

Silicon Photodiode, RoHS Compliant

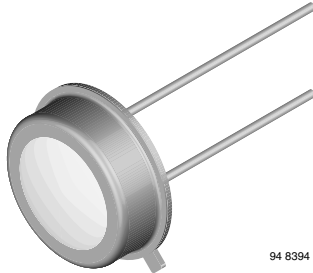

DESCRIPTION

BPW21R is a planar Silicon PN photodiode in a hermetically sealed short TO-5 case, especially designed for high precision linear applications.

Due to its extremely high dark resistance, the short circuit photocurrent is linear over seven decades of illumination level.

On the other hand, there is a strictly logarithmic correlation between open circuit voltage and illumination over the same range.

The device is equipped with a flat glass window with built in color correction filter, giving an approximation to the spectral response of the human eye.

FEATURES

- Package type: leaded
- Package form: TO-5
- Dimensions (in mm): Ø 8.13
- Radiant sensitive area (in mm²): 7.5
- High photo sensitivity
- Adapted to human eye responsivity
- Angle of half sensitivity: $\varphi = \pm 50^\circ$
- Hermetically sealed package
- Cathode connected to package
- Flat glass window
- Low dark current
- High shunt resistance
- High linearity
- Lead (Pb)-free component in accordance with RoHS 2002/95/EC and WEEE 2002/96/EC



RoHS
COMPLIANT

APPLICATIONS

- Sensor in exposure and color measuring purposes

PRODUCT SUMMARY

COMPONENT	I_{ra} (mA)	φ (deg)	$\lambda_{0.5}$ (nm)
BPW21R	9	± 50	420 to 675

Note

Test condition see table "Basic Characteristics"

ORDERING INFORMATION

ORDERING CODE	PACKAGING	REMARKS	PACKAGE FORM
BPW21R	Bulk	MOQ: 500 pcs, 500 pcs/bulk	TO-5

Note

MOQ: minimum order quantity

ABSOLUTE MAXIMUM RATINGS

PARAMETER	TEST CONDITION	SYMBOL	VALUE	UNIT
Reverse voltage		V_R	10	V
Power dissipation	$T_{amb} \leq 50^\circ\text{C}$	P_V	300	mW
Junction temperature		T_j	125	$^\circ\text{C}$
Operating temperature range		T_{amb}	- 40 to + 125	$^\circ\text{C}$
Storage temperature range		T_{stg}	- 40 to + 125	$^\circ\text{C}$
Soldering temperature	$t \leq 5\text{ s}$	T_{sd}	260	$^\circ\text{C}$
Thermal resistance junction/ambient	Connected with Cu wire, 0.14 mm ²	R_{thJA}	250	K/W

Note

$T_{amb} = 25^\circ\text{C}$, unless otherwise specified



BASIC CHARACTERISTICS						
PARAMETER	TEST CONDITION	SYMBOL	MIN.	TYP.	MAX.	UNIT
Forward voltage	$I_F = 50 \text{ mA}$	V_F		1.0	1.3	V
Breakdown voltage	$I_R = 20 \text{ }\mu\text{A}, E = 0$	$V_{(BR)}$	10			V
Reverse dark current	$V_R = 5 \text{ V}, E = 0$	I_{ro}		2	30	nA
Diode capacitance	$V_R = 0 \text{ V}, f = 1 \text{ MHz}, E = 0$	C_D		1.2		nF
	$V_R = 5 \text{ V}, f = 1 \text{ MHz}, E = 0$	C_D		400		pF
Dark resistance	$V_R = 10 \text{ mV}$	R_D		38		$G\Omega$
Open circuit voltage	$E_A = 1 \text{ klx}$	V_o	280	450		mV
Temperature coefficient of V_o	$E_A = 1 \text{ klx}$	TK_{V_o}		- 2		mV/K
Short circuit current	$E_A = 1 \text{ klx}$	I_k	4.5	9		μA
Temperature coefficient of I_k	$E_A = 1 \text{ klx}$	TK_{I_k}		- 0.05		%/K
Reverse light current	$E_A = 1 \text{ klx}, V_R = 5 \text{ V}$	I_{ra}	4.5	9		μA
Sensitivity	$V_R = 5 \text{ V}, E_A = 10^{-2} \text{ to } 10^5 \text{ lx}$	S		9		nA/lx
Angle of half sensitivity		φ		± 50		deg
Wavelength of peak sensitivity		λ_p		565		nm
Range of spectral bandwidth		$\lambda_{0.5}$		420 to 675		nm
Rise time	$V_R = 0 \text{ V}, R_L = 1 \text{ k}\Omega, \lambda = 660 \text{ nm}$	t_r		3.1		μs
Fall time	$V_R = 0 \text{ V}, R_L = 1 \text{ k}\Omega, \lambda = 660 \text{ nm}$	t_f		3.0		μs

Note

$T_{amb} = 25 \text{ }^\circ\text{C}$, unless otherwise specified

BASIC CHARACTERISTICS

$T_{amb} = 25 \text{ }^\circ\text{C}$, unless otherwise specified

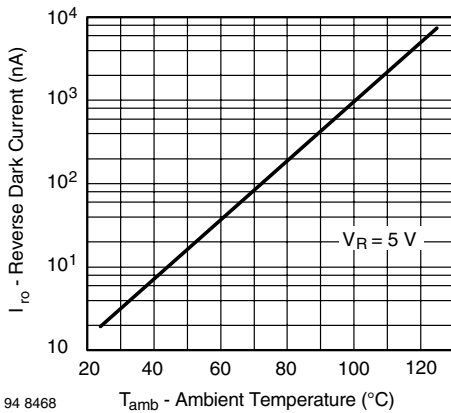

Fig. 1 - Reverse Dark Current vs. Ambient Temperature

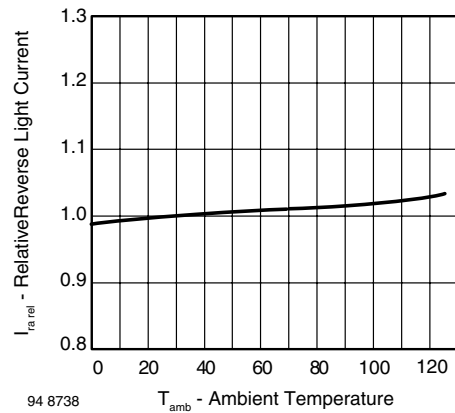

Fig. 2 - Relative Reverse Light Current vs. Ambient Temperature

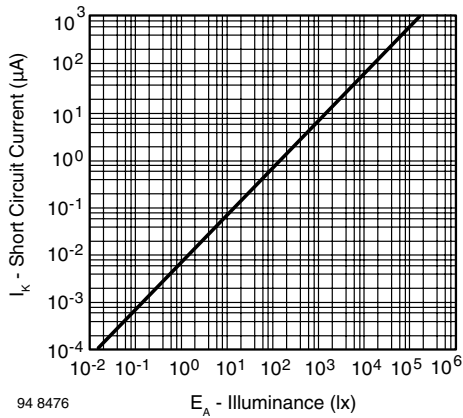

Fig. 3 - Short Circuit Current vs. Illuminance

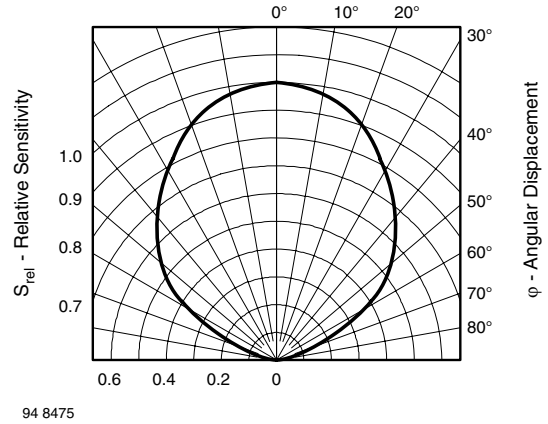

Fig. 6 - Relative Radiant Sensitivity vs. Angular Displacement

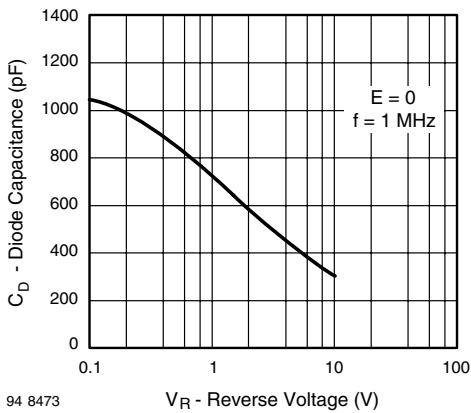

Fig. 4 - Diode Capacitance vs. Reverse Voltage

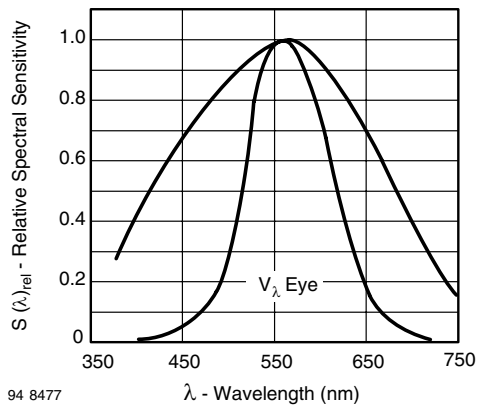
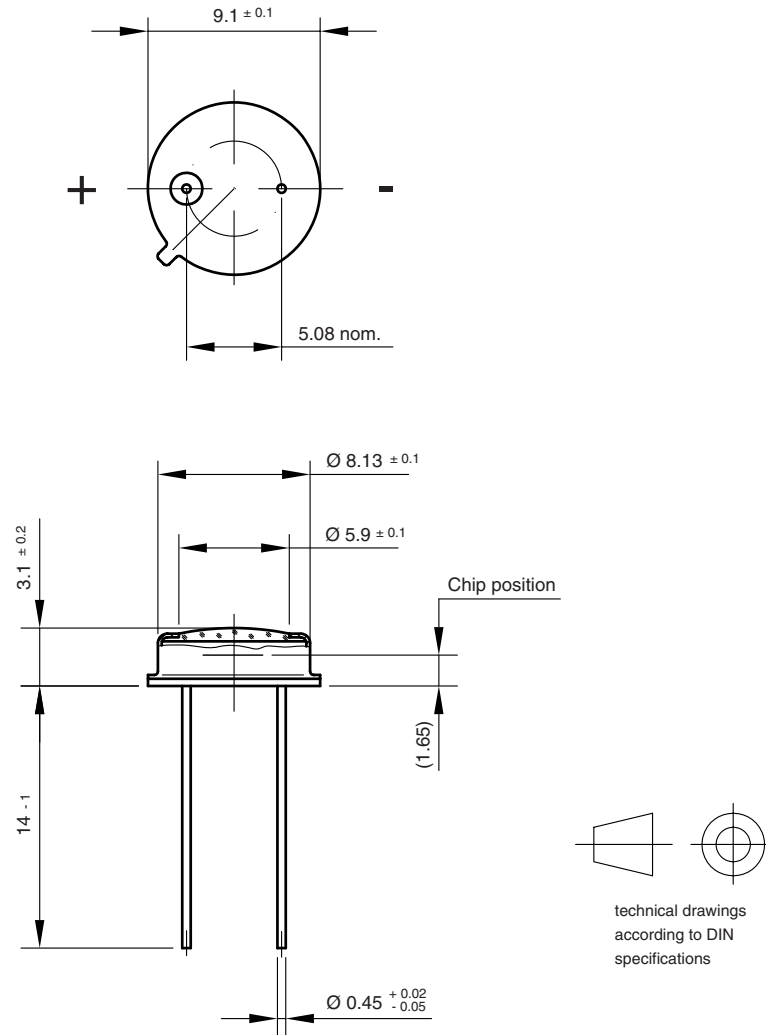

Fig. 5 - Relative Spectral Sensitivity vs. Wavelength



PACKAGE DIMENSIONS in millimeters



Drawing-No.: 6.511-5002.01-4
Issue:1; 01.07.96
96 12181



Disclaimer

All product specifications and data are subject to change without notice.

Vishay Intertechnology, Inc., its affiliates, agents, and employees, and all persons acting on its or their behalf (collectively, "Vishay"), disclaim any and all liability for any errors, inaccuracies or incompleteness contained herein or in any other disclosure relating to any product.

Vishay disclaims any and all liability arising out of the use or application of any product described herein or of any information provided herein to the maximum extent permitted by law. The product specifications do not expand or otherwise modify Vishay's terms and conditions of purchase, including but not limited to the warranty expressed therein, which apply to these products.

No license, express or implied, by estoppel or otherwise, to any intellectual property rights is granted by this document or by any conduct of Vishay.

The products shown herein are not designed for use in medical, life-saving, or life-sustaining applications unless otherwise expressly indicated. Customers using or selling Vishay products not expressly indicated for use in such applications do so entirely at their own risk and agree to fully indemnify Vishay for any damages arising or resulting from such use or sale. Please contact authorized Vishay personnel to obtain written terms and conditions regarding products designed for such applications.

Product names and markings noted herein may be trademarks of their respective owners.